

Dimensões:  
(Escala 1:1)

PERSPECTIVA:

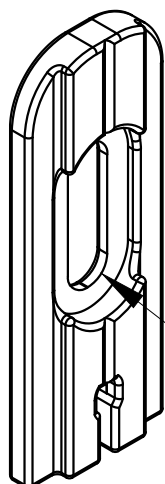

Sistema  
de regulagem e  
travamento

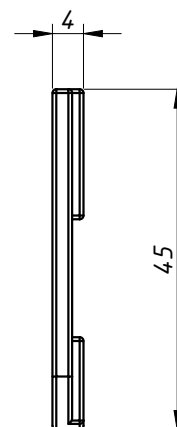
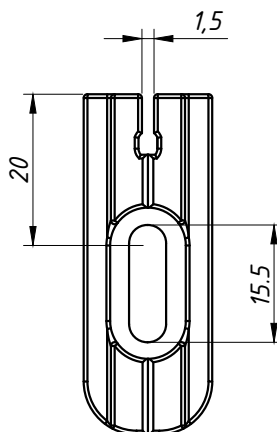
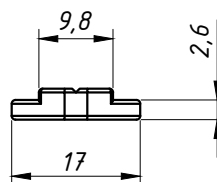

DETALHES DE APLICAÇÃO:  
(sem escala)

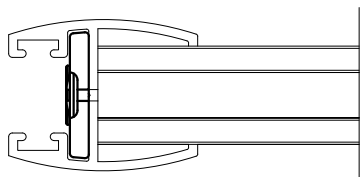

LE - 1614

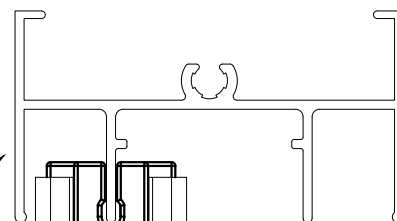

Sistema  
de regulagem e  
travamento

LE - 1659

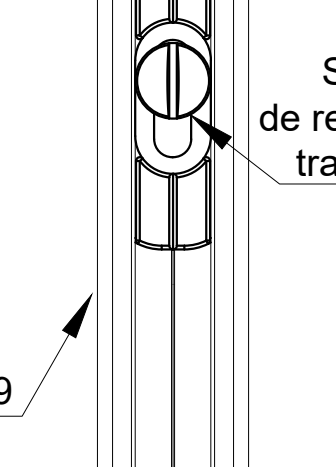

CARACTERÍSTICAS:

Componentes:	Matéria-prima:
Estrutura	Poliamida
Trava	Poliacetal

Acabamento	Preto
------------	-------

Embalagem	200 guias
-----------	-----------

CÓDIGO	ACABAMENTO
GUI-0202	Preto

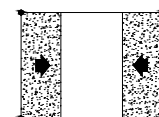

JANELAS  
E PORTAS  
DE CORRER