

DIMENSÕES:
(escala 1:1)

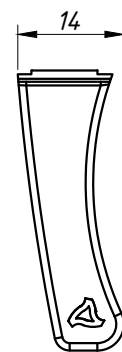

PERSPECTIVA:
(sem escala)

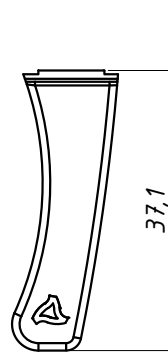
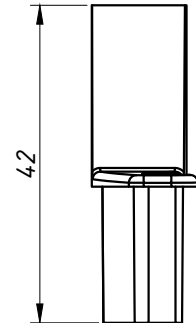
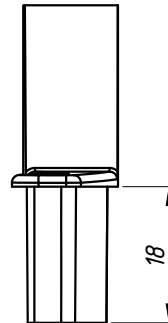
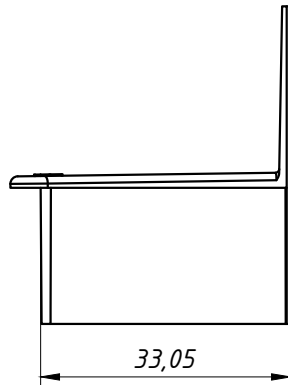
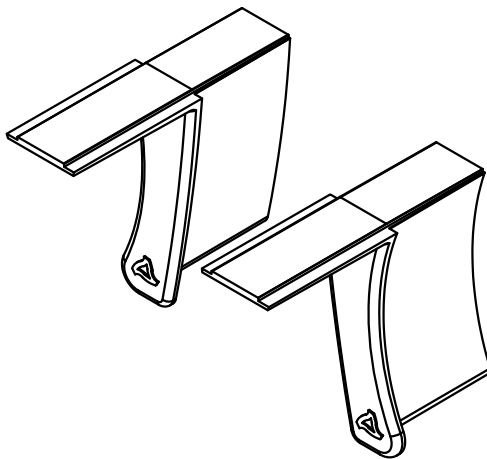

DETALHE DE APLICAÇÃO:
(sem escala)

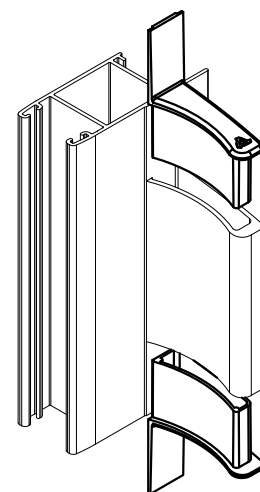

CARACTERÍSTICAS:

Componentes:	Matéria-prima:
Estrutura	Poliamida

Acabamento	Preto
	Branco

Embalagem	10 Pares
-----------	----------

CÓDIGO	ACABAMENTO
NYL-231	Preto
NYL-231NB	Branco

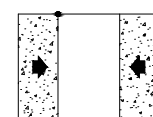

JANELAS
E PORTAS
DE CORRER