

AURUM

SISTEMA PARA PERGOLADO SEM FIXAÇÃO APARENTE

Recebe aplicação de LED.

Atende vãos de até 3,5x2,5m entre colunas.

Flexível e customizável.

Alta qualidade e durabilidade.

O melhor custo/benefício do mercado.



ALUMICONTE



Utilizar vidro temperado e laminado de 5+5mm (Vidro de Segurança)



Recebe aplicação em LED



Vãos de até 3,5m entre as colunas

PERFIS PARA PERGOLADO AURUM

MONTAGEM

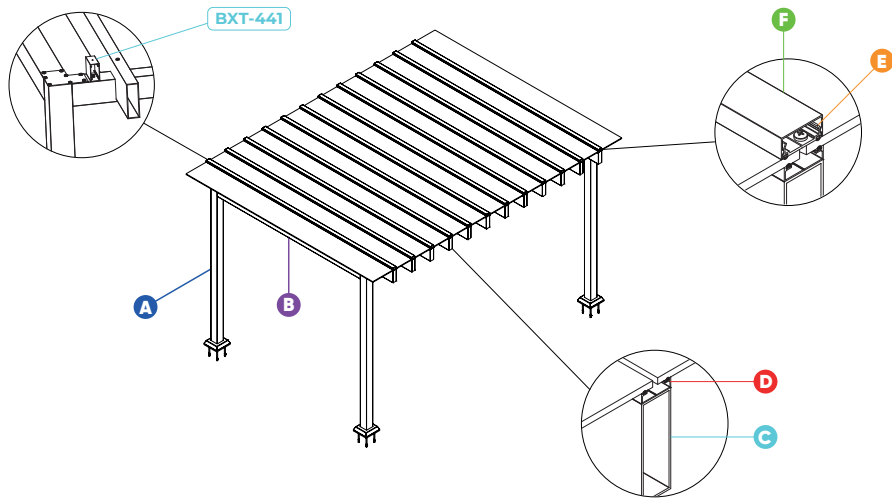

A PER-2112

Tubo Quadrado

3,672 Kg/m

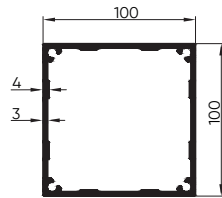

B PER-2113

Tubo Quadrado para LED

3,482 Kg/m

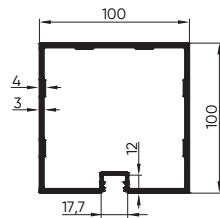

FIXAÇÃO
Parafuso 5,5mm x 3"



DIFUSOR
DIF-001



BXT-410

Clic Arremate - Acabamento

0,106 Kg/m

Tampa para aplicar no PER-2113 caso não utilize LED

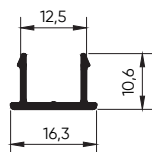

C PER-2111

Tubo Retangular

3,254 Kg/m

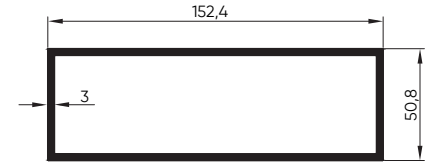
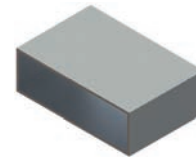

BXT-441

Tubo Retangular

0,969 Kg/m

Tubo para fixar o PER-2111 nas travessas

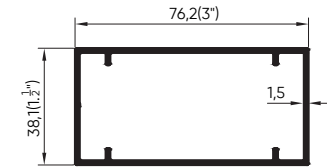
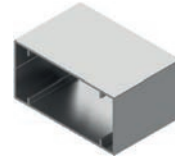

FIXAÇÃO
Parafuso 6,3mm x 1"½



D PER-2116

Complemento Externo

0,447 Kg/m

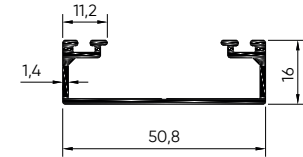

VEDAÇÃO
BT-001



VEDAÇÃO
BT-002



E PER-2117

Complemento Extrutural Cobertura

0,448 Kg/m

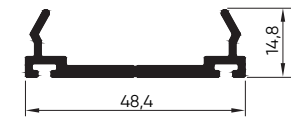
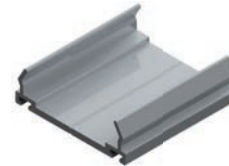

VEDAÇÃO
BT-001



VEDAÇÃO
BT-002



F PER-2118

Acabamento do Complemento

0,378 Kg/m

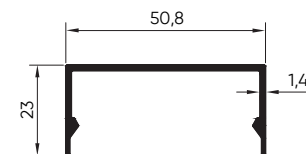
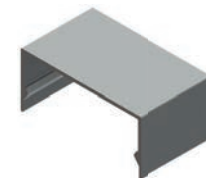

COMPONENTES

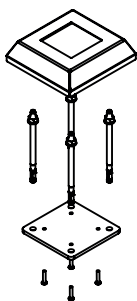

APLICAÇÃO

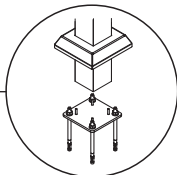

Conjunto

PARA FIXAÇÃO
PERG-001
CANOPLA - PERG-007
CONJUNTO INFERIOR - PERG-008

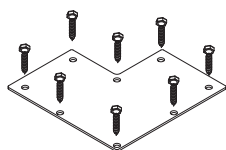

APLICAÇÃO

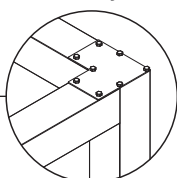

Tampa

PARA PERFIL PER-2112
PERG-002

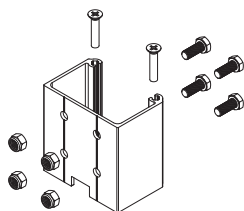

APLICAÇÃO

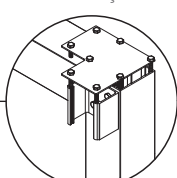

Suporte estrutural

PARA TRAVESSA PER-2113
PERG-005

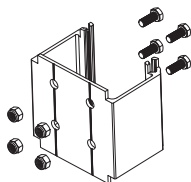

APLICAÇÃO

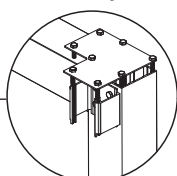

Suporte estrutural

PARA TRAVESSA PER-2112
PERG-006

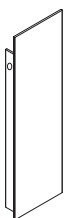

APLICAÇÃO

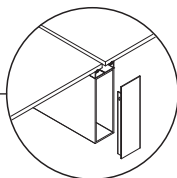

Tampa

PARA PERFIL PER-2111
PERG-003

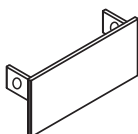

APLICAÇÃO

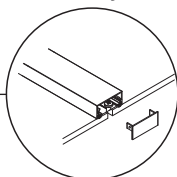

Tampa

PARA PERFIL PER-2118
PERG-004

ATENÇÃO: perfis e componentes em escalas variadas. Utilize as cotas como base de informação. Unidade de medida: **mm**.
Os desenhos aqui contidos possuem medidas teóricas de massa e tolerâncias dimensionais de acordo com a ABNT NBR-8116, podendo haver variações dessas informações no produto final.



QUALIDADE
e cuidado com o
MEIO AMBIENTE
certificados.



ALUMICONTE

54 3447 4000 | VILA FLORES | RS | SERRA GAÚCHA
WWW.ALUMICONTE.COM.BR